

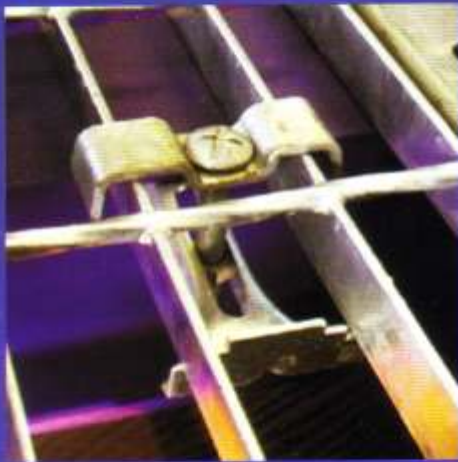

Kanade Anand Udyog Private Limited





Anand Udyog

a Partnership Company was founded in 1985. The Company was converted into a Private Limited Company in 2005. The Company is owned by Kanade Family. The Company is run by Mr. Dinanath Kanade and Mr. Sunil Kanade.

All the manufacturing units of the Company are located in MIDC, Ambarnath, Dist - Thane (50 Kms. From Mumbai). There are Three products Lines

1. Electroforged Floor Gratings
2. Cable Trays and
3. Transmission Lines Towers and Structures.

Besides this Company has captive galvanising facility with bath size of 10 Mtrs. Length x 1.5 Mtrs. Width x 1.1 Mtrs. Depth.

The main product of group is Electroforged Floor Grating. There are production lines with monthly capacity of 2500 MT.

Clients

- Bharat Heavy Electricals Limited (BHEL)
- Reliance Petroleum Limited (RPL)
- Reliance Industries Limited (RIL)
- Shapoorji Pallonji & Co. Ltd.
- Black & Veatch (U.S.A.) Consulting Co. Ltd.
- Heurtey Petrochem Equipments Pvt. Ltd.
- Indian Oil Tanking Limited (IOCL)
- Samsung Engineering Ltd.
- Larsen & Toubro Limited (HARP, Baroda)
- Larsen & Toubro Limited (ECC)
- Larsen & Toubro Limited (Group - II, Powai)
- Toyo Engineering India Ltd.
- Lanco Infrastructure Limited
- Thyssenkrupp Industries India Ltd.
- Punj Llyod Ltd.
- Alstom Limited

Electroforge Technology

Gratings are manufactured by PLC controlled equipment which combines high hydraulic pressure (more than 100 Tonnes) and high electric current (approx 2200 amps) to electroforge the cross bar & bearing bar into a single standard panel.

The Electroforming process eliminates any crack or open joint. The strength of bearing bar is also retained. The square twisted bar (cross bar) provides excellent antiskid property.

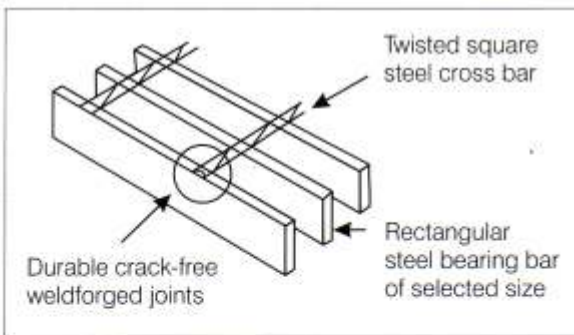

We can provide the following standard type steel gratings.

Tables of Bars

Bearing bar

Bearing bar sizes in mm	30 x 5, 32 x 5, 30 x 3, 25 x 3, 25 x 5, 40 x 5
Bearing bar types	Plain or serrated

Cross bar

Cross bar sizes	6 mm, 8 mm
Cross bar types	Round or square (twisted)

Table of gratings panel sizes in mm

R3 & RR3	6000 x 995
R4 & RR4	6000 x 995

Standard Welded Gratings

Standard electroforged gratings with bearing bars spaced at 41 mm on center and cross bars at 100 mm on center.

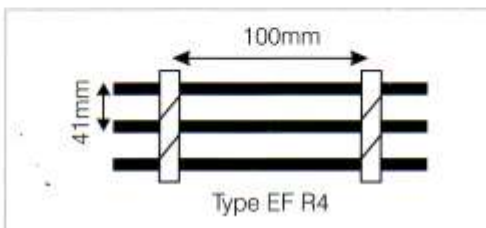

Standard electroforged gratings with bearing bars spaced at 30 mm on center and cross bars at 50 mm on center.

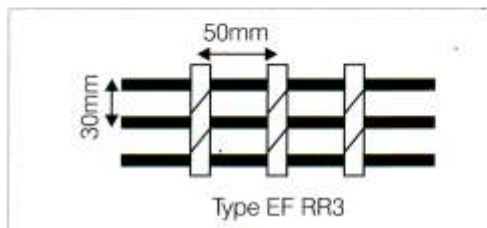

Standard electroforged gratings with bearing bars spaced at 30 mm on center and cross bars at 100 mm on center.

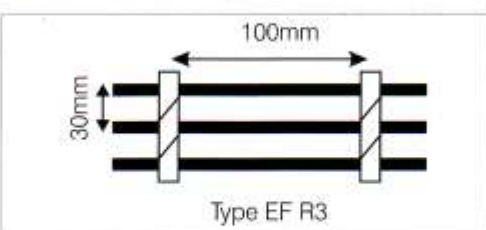

Standard electroforged gratings with bearing bars spaced at 41 mm on center and cross bars at 50 mm on center.

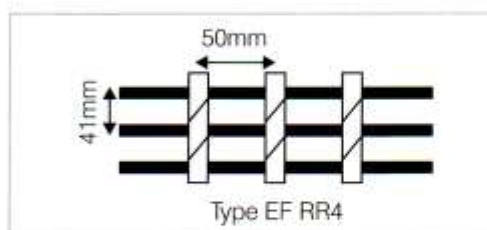

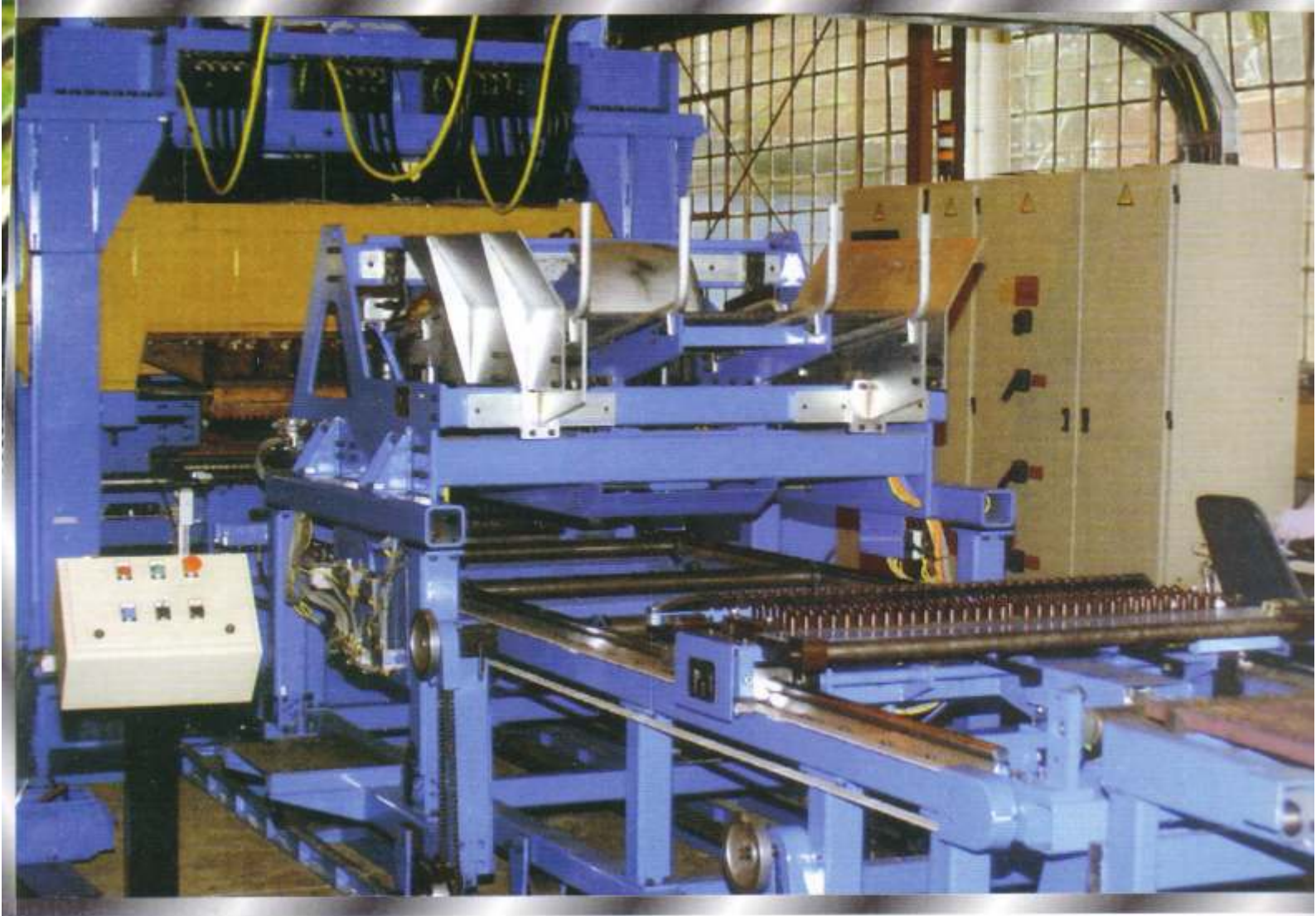

Cutting
Machine



Close view of
Electroforming Technology

Electroforge Machine



Feeding System



Our Products

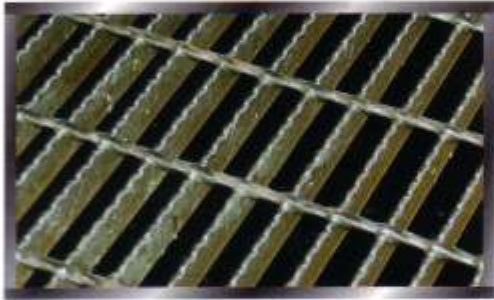

Serrated Grating

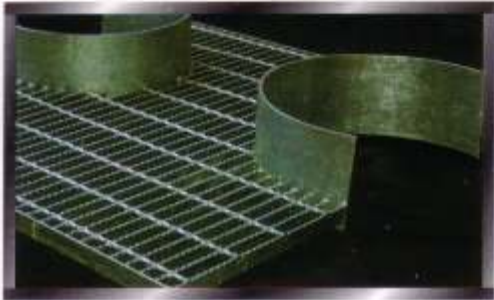

Grating with toe plate

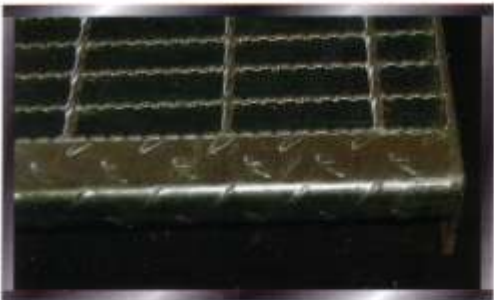

Stair Tread with
Chequered plate nosing



Stair Tread with Carrier Plate



Finish : Self Coloured | Red oxide primer
Hot dip Galvanised | Other paints

Seven tanks system before Galvanising



Hot dip Galvanising bath

995 mm x 6000 mm panels

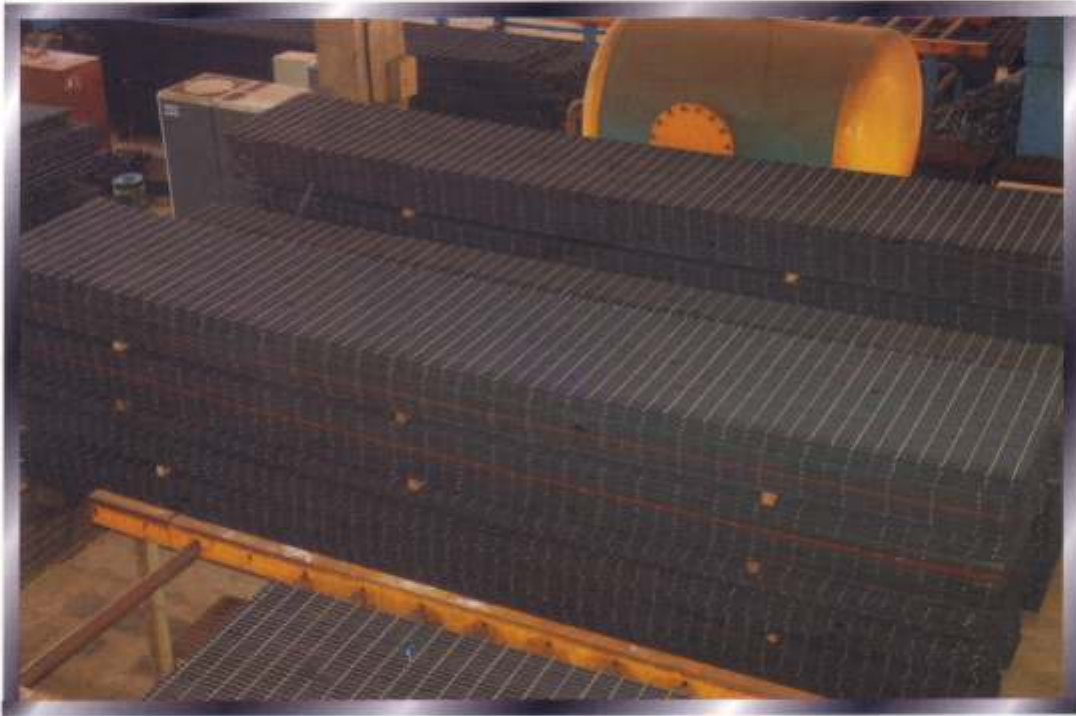

995 mm x 6000 mm Bundled panels

Kanade Anand Udyog Pvt. Ltd.

3/12, Poddar Building No. 2, Near Sandhurst Road, Rly. Station, Dr. Maisheri Road, Mumbai 400 009.

Tel. : 91-22 2371 5519 / 2377 5473 / 2374 0444 | Fax : 91-22 2373 9722 | Email : kanadeanandudyog@hotmail.com

Works : E-47, MIDC Anandnagar, Ambarnath (E), Dist. Thane. | Tel./Fax : 0251- 2620147